

Introduction to Laser Safety

By Glenn Chapman
School of Engineering Science
Simon Fraser University

glennc@cs.sfu.ca

Lecture notes at
<http://www.ensc.sfu.ca/people/faculty/chapman/e894/lasersafety.html>

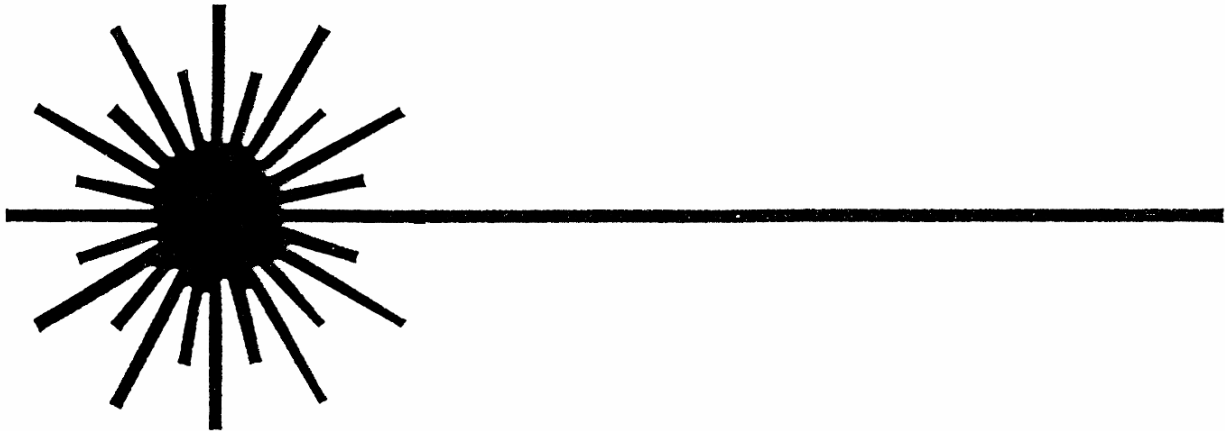

Why is Laser Safety Important

- Laser usage is growing rapidly
- e.g. laser points, CD/DVD, industrial applications
- Heavy use now in laboratories for research, analysis
- Some laser pointers are already at the danger level
- Need to know the basics of laser safety



"Now you know the difference between a moon beam and a laser beam!"

Laser Safety & the Human Eye

- Recall the human eye is a simple single lens system
- Crystalline lens provide focus
- Cornea: outer surface protection
- Iris: control light
- Retina: where image is focused
- Note images are inverted

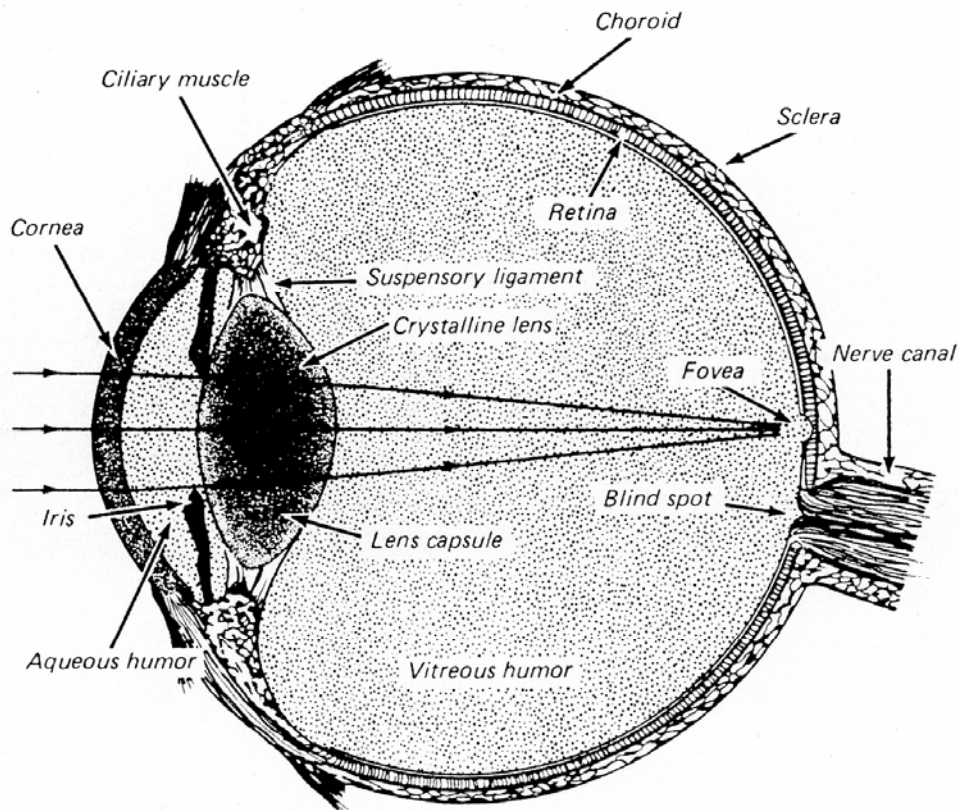

FIGURE 10A

A cross-sectional diagram of a human eye, showing the principal optical components and the retina.

Laser Safety

- Most potential for laser damage to eye
- 4 main wavelength regions
- UV ($<0.4 \mu\text{m}$) absorbed by Cornea
- Visible ($0.4\text{-}0.7 \mu\text{m}$) focused on retina
- Invisible Near IR (NIR) ($0.7\text{-}1.4 \mu\text{m}$) focused on retina
- Long wavelength Infrared ($>1.4 \mu\text{m}$) absorbed by Cornea

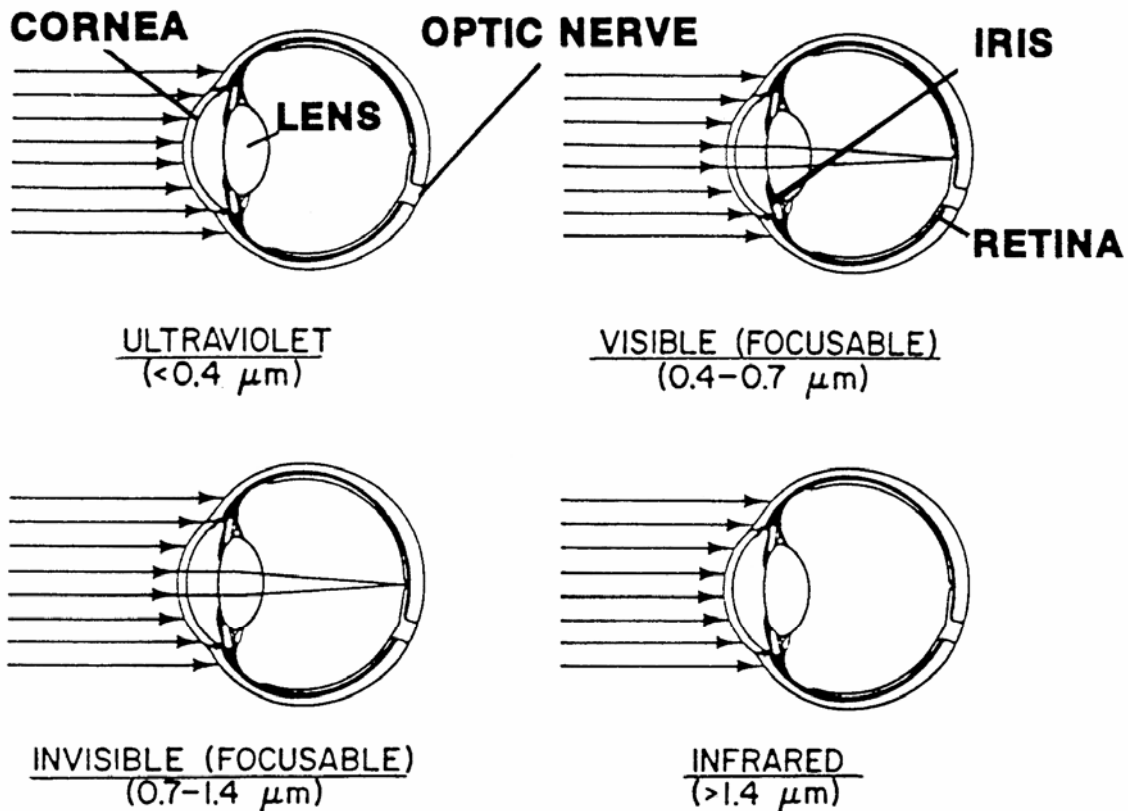

Figure 2.2 Absorption and transmission of laser light by components of the ocular system.

Damage Mechanisms

Continuous Wave (CW) laser light

- Laser beam operates for long periods
- Power measured in W/cm^2
- Thermal processes (burns)
charring of skin, blisters
- Photochemical Degeneration (UV effect)

Pulsed

- Laser operates in single or repeated pulses
- Typical pulses msec to nsec.
- Measured in energy per pulse J/cm^2
- Note peak power density increases as pulse duration decreases
- Thermal & Photochemical processes
- Blast Damage for < 10 nsec
shock & acoustic waves from laser pulse
cause their own damage

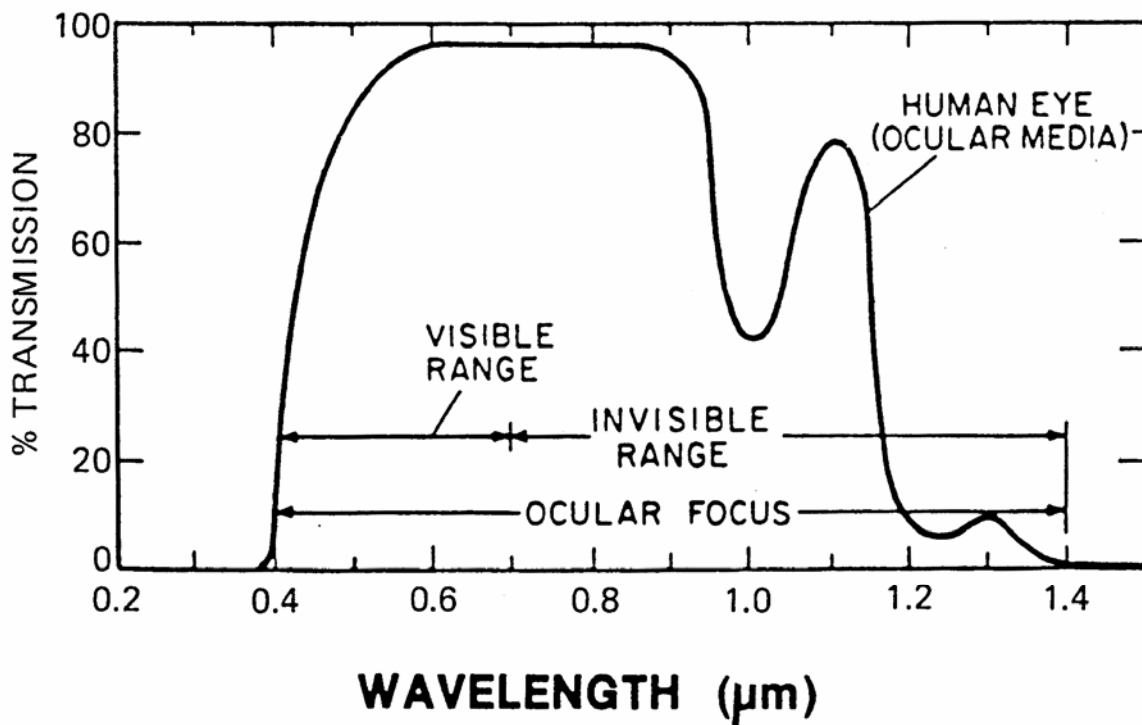

Figure 3.3 Transmission curve for human ocular system of wavelengths in the ocular focus region.

• Example of Laser Eye Damage

- Visible/Near IR Laser lesions on the retina
Example with Nd:Yag 1.04 μm NIR
- Detected by dilating eyes and inspecting back of eye
- Cornea damage
Burns: from Long IR (e.g. CO₂ laser 10.4 μm)
Cornea Cataract from UV exposure
- Regular eye exams important for high power laser users



Retina Eye damage (Nd:Yag)
(1.04 μm NIR)

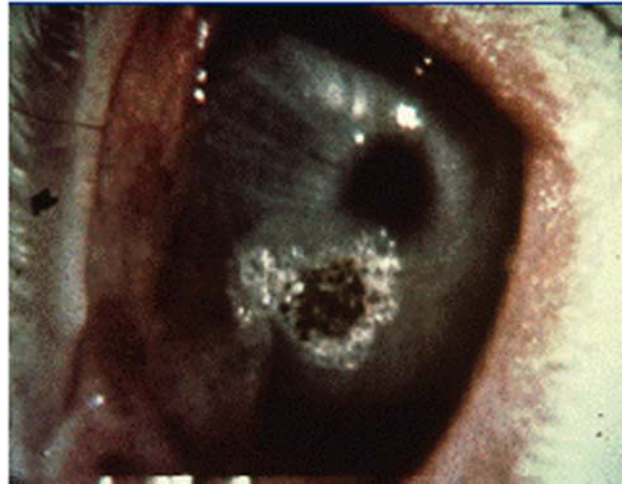

Corneal laser damage
CO₂ (10.4 μm IR)

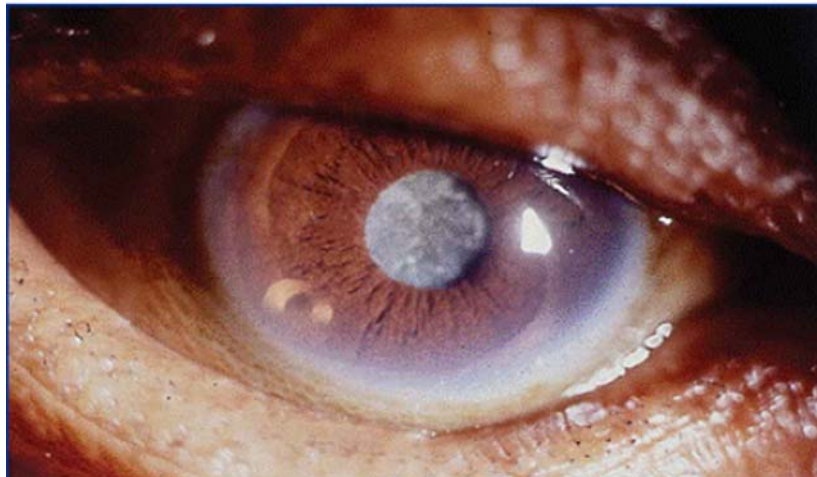

Cornea Cataract from UV exposure

Laser Eye Damage Thresholds

- Damage differs for pulsed and CW
- Note: Sunlight = 0.1 W/cm^2 at the equator at Noon
- Damage threshold lowest at $1.1 \mu\text{m}$
 Thus Nd:Yag Very Dangerous wavelength
- Nd:Yag dangerous for both CW & pulsed

Available intensities	UV .2-.3 μm	2.7 μm	IR 10.6 μm
	CW (W/cm^2) ^b	10×10^{-3}	$(100 \times 10^{-3})^a$
pulsed (J/cm^2):			
100 nsec	(4×10^{-3})	4×10^{-3}	(5×10^{-3})
30 nsec	(4×10^{-3})	(4×10^{-3})	(5×10^{-3})
20 nsec	(4×10^{-3})	(4×10^{-3})	(5×10^{-3})
1 nsec	(4×10^{-3})	4×10^{-3}	5×10^{-3}
30 psec	$(<4 \times 10^{-3})$	$(<4 \times 10^{-3})$	$(<5 \times 10^{-3})$

^aAll parenthetical values are estimates by the author.

^bAssume one second maximum exposure.

Figure 3.1 Approximate damage threshold values for corneal tissue for various pulsed and CW lasers (minimum reported).

Available intensities	Ocular focus	
	.5-.7 μm	1.1 μm
CW (W/cm^2) ^b	10×10^{-3}	$<5 \times 10^{-3}$
pulsed (J/cm^2):		
100 nsec	$(100 \times 10^{-6})^a$	(100×10^{-6})
30 nsec	70×10^{-6}	(100×10^{-6})
20 nsec	130×10^{-6}	105×10^{-6}
1 nsec	(120×10^{-6})	(100×10^{-6})
30 psec	18×10^{-6}	9×10^{-6}

^aAll parenthetical values are estimates by the author.

^bAssume one second maximum exposure.

Why the Human Eye is so Sensitive

- Crystalline lens focuses the light to high power
- 1 mm laser beam becomes 2 micron spot (with ideal focus)
- Power density increase by $\sim 62,500\times$
- 10 mW/cm^2 laser beam at the cornea becomes 625 W/cm^2 at retina
- Eg. Sunlight: 0.1 W/cm^2 at cornea becomes **6.2 KW/cm^2** at retina
- Way above tissue damage threshold
- 1 mW laser, 1mm diameter pointer becomes 15 KW/cm^2 at retina
- Fortunately eye is not a perfect lens (spots are larger)
- Blink reflex saves us with low power laser pointer

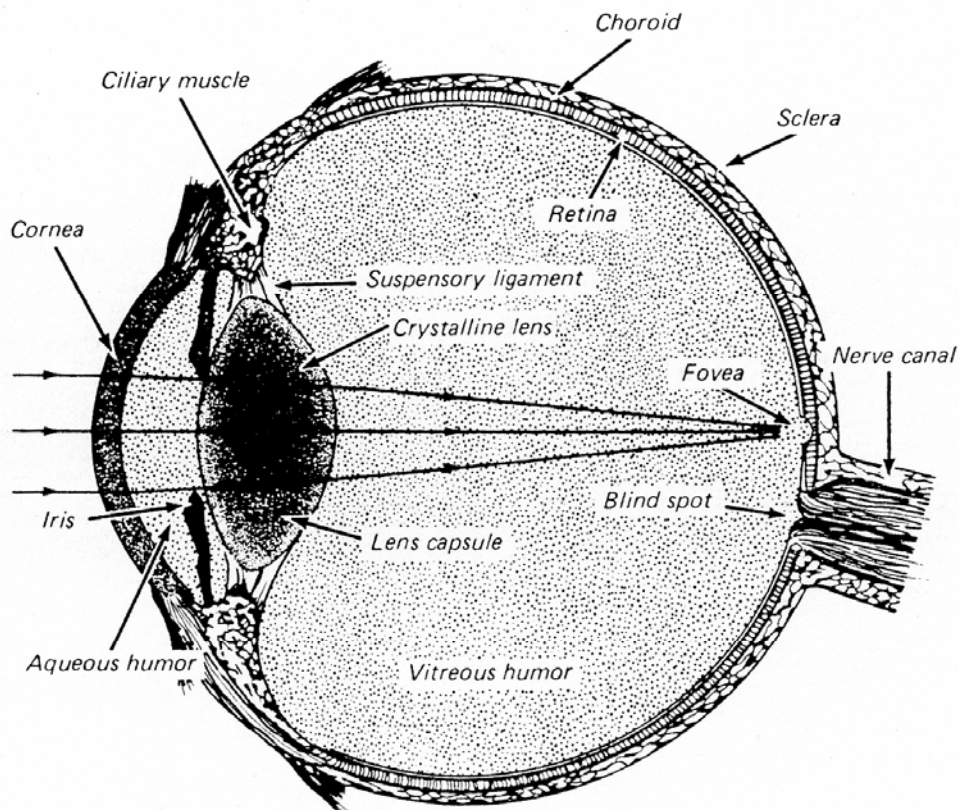

FIGURE 10A

A cross-sectional diagram of a human eye, showing the principal optical components and the retina.

Typical Laser Safety Goggles

- Many designs: simple sunglass type to full goggles
- Prescription ground goggles best if use glasses
- Goggle colour will determine type of laser effective on
- Must get safety goggles matched to the wavelengths used
Not just the laser used
- Goggle have range on front or side in small letters



Prescription ground goggle
Argon laser 400-513 nm



Nd:Yag Laser goggle
1064, 533, 354, 266 nm



Argon Laser goggle
400-513 nm



Ruby Laser goggle
694 nm



Diode Laser goggle
670 nm - NIR



Filters for Laser Protection

- Best use Schott Glass filters
- Very steep cutoff wavelength
- Can take high power radiation
- Filters measured by Optical Density (OD)

$$OD = \log_{10} \left(\frac{I_i}{I_t} \right)$$

I_i = incident light

I_t = transmitted light

- eg OD 2 cuts light by 100
OD 1.48 cuts light by 30
- Want at least OD 5 in laser light to remove danger
- But low OD in non laser wavelengths
- Tricky for some lasers: eg Nd:Yag with doubling
want both NIR and below 550 nm high absorption

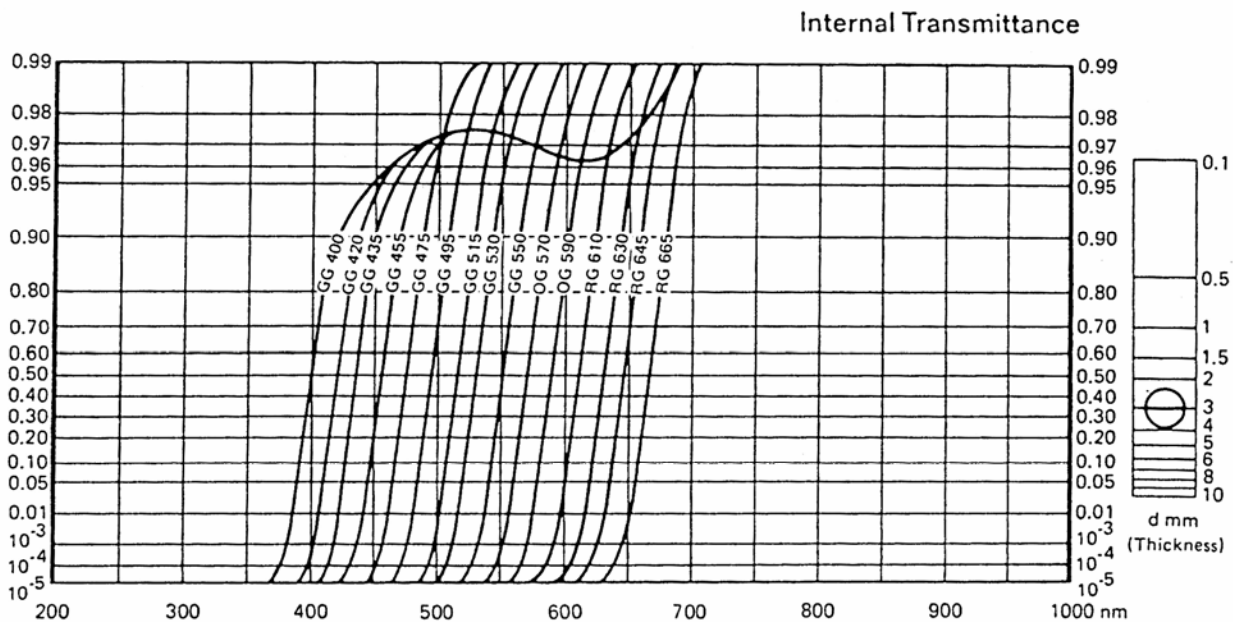

Figure 8.7 Transmittance curves for Schott's OG and RG glass series.

Laser Eye Damage Reports

- Almost all reported damage
due to Not Wearing Safety Goggles
- Some problems when Goggles slid up
- Many times beam reflected off of surfaces
- Problem surfaces: Mirrors, windows,
watch crystals, rings, glass covers of instruments
- Also back reflection from optical devices
lenses, filters, shutters
- Remember: eye damage time is measured in microseconds
- Many damage thresholds set using animal experiments
not set by known human damage
- Lasers are most deadly when you use them the most
Most damage reports are from people with long experience

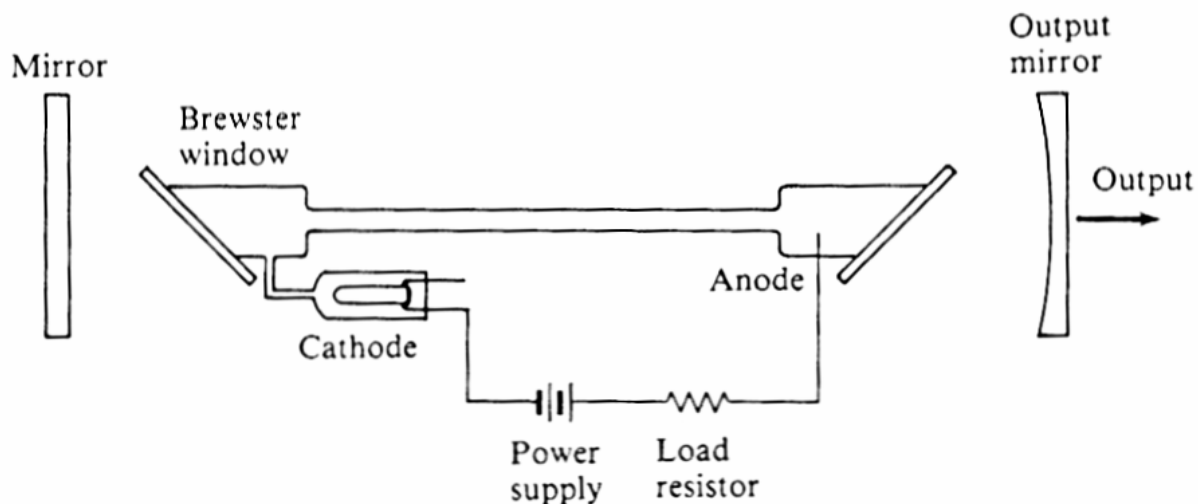

Fig. 2.25 Schematic construction of a low-power gas laser such as the helium–neon laser. The load resistor serves to limit the current once the discharge has been initiated.

Skin Damage

- Skin shows most damage at UV
only 3 mW required for damage
- Damage threshold relatively high at 1.1 μm
Thus Nd:Yag not as important here
Reason is wavelength penetrates skin
- Visible and long IR more problem
- Thermal effect more important with CW

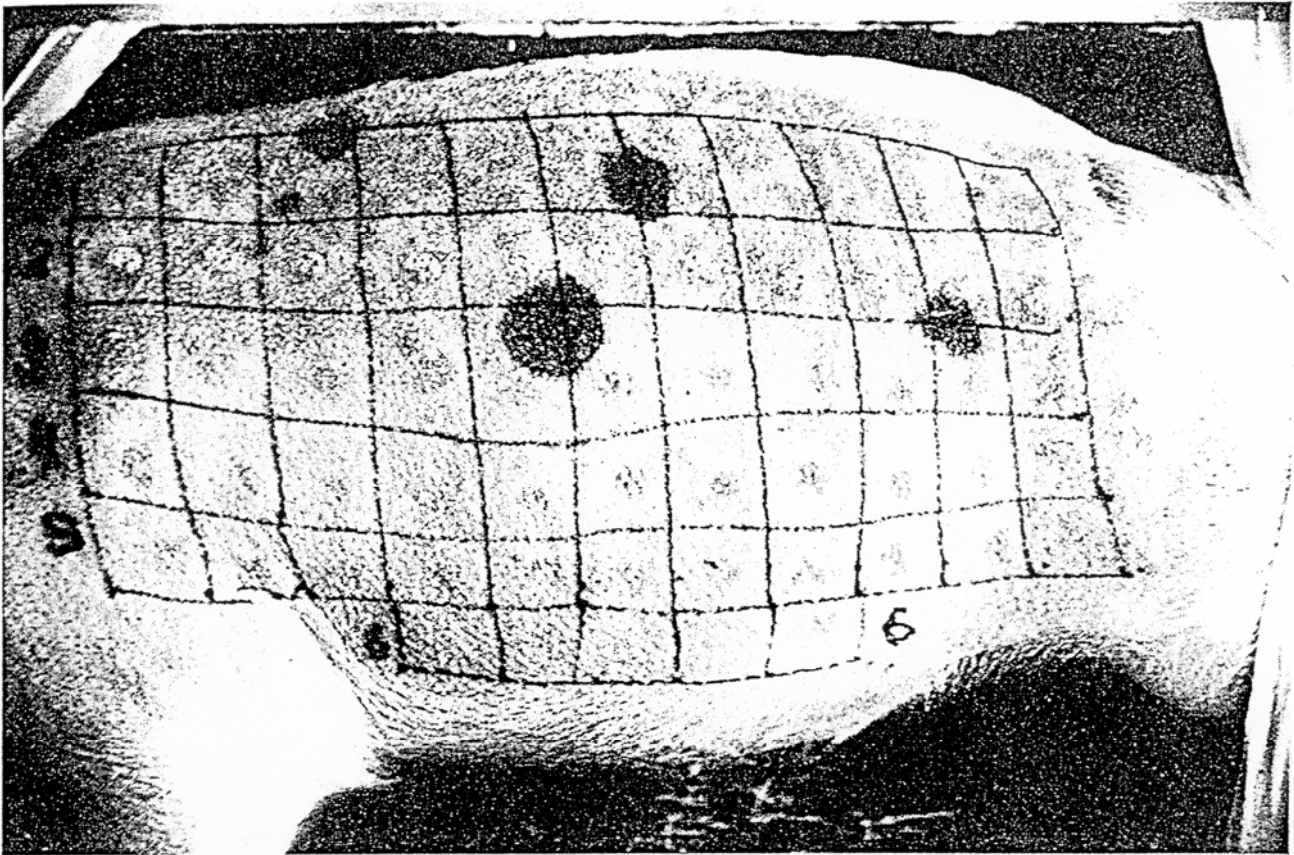

Figure 4.2 Photograph of piglet skin used in damage threshold experiments.
(Courtesy of James Rockwell and Los Alamos National Laboratory.)

Skin Damage Threshold Values

- Skin damage depends on skin colour in visible/UV range
- Charts for other than Caucasian not listed in US specs
- Note for skin damage Nd:Yag has the highest threshold
- Reason is that the absorption coefficient is smallest
ie beam has to heat a larger volume

Available intensities	UV	Ocular focus			IR
	.2-.3 μm	.5-.7 μm	1.1 μm	2.7 μm	10.6 μm
CW (W/cm^2) ^b	3×10^{-3}	4	28	(3) ^a	3
pulsed (J/cm^2):					
100 nsec	(300×10^{-3})	110×10^{-3}	2.2	300×10^{-3}	(300×10^{-3})
30 nsec	(200×10^{-3})	(100×10^{-3})	(2.0)	(200×10^{-3})	(200×10^{-3})
20 nsec	(200×10^{-3})	(100×10^{-3})	(2.0)	(200×10^{-3})	(200×10^{-3})
1 nsec	(200×10^{-3})	(100×10^{-3})	(2.0)	(200×10^{-3})	230×10^{-3}
30 psec	(200×10^{-3})	(100×10^{-3})	(2.0)	(200×10^{-3})	(200×10^{-3})

^aAll parenthetical values are estimates by the author.

^bAssume one second maximum exposure.

Figure 4.1 Skin damage threshold values for laser radiation (Caucasian).

Skin Damage CW Maximum Permissible Exposure

- Skin Maximum Permissible Exposure (MPE) \ll damage threshold
- Set by ANSI Z136.1-2000
- CW below 400 nm at 1 mW/cm^2
- CW 400-1400 function of wavelength
- All for an illumination area $< 3.5 \text{ mm}$ diameter
- Note: before doing any human/animal experiments
Must get permission from SFU Research Ethics (Policy R20.02)
- Use MPE for safety calculations

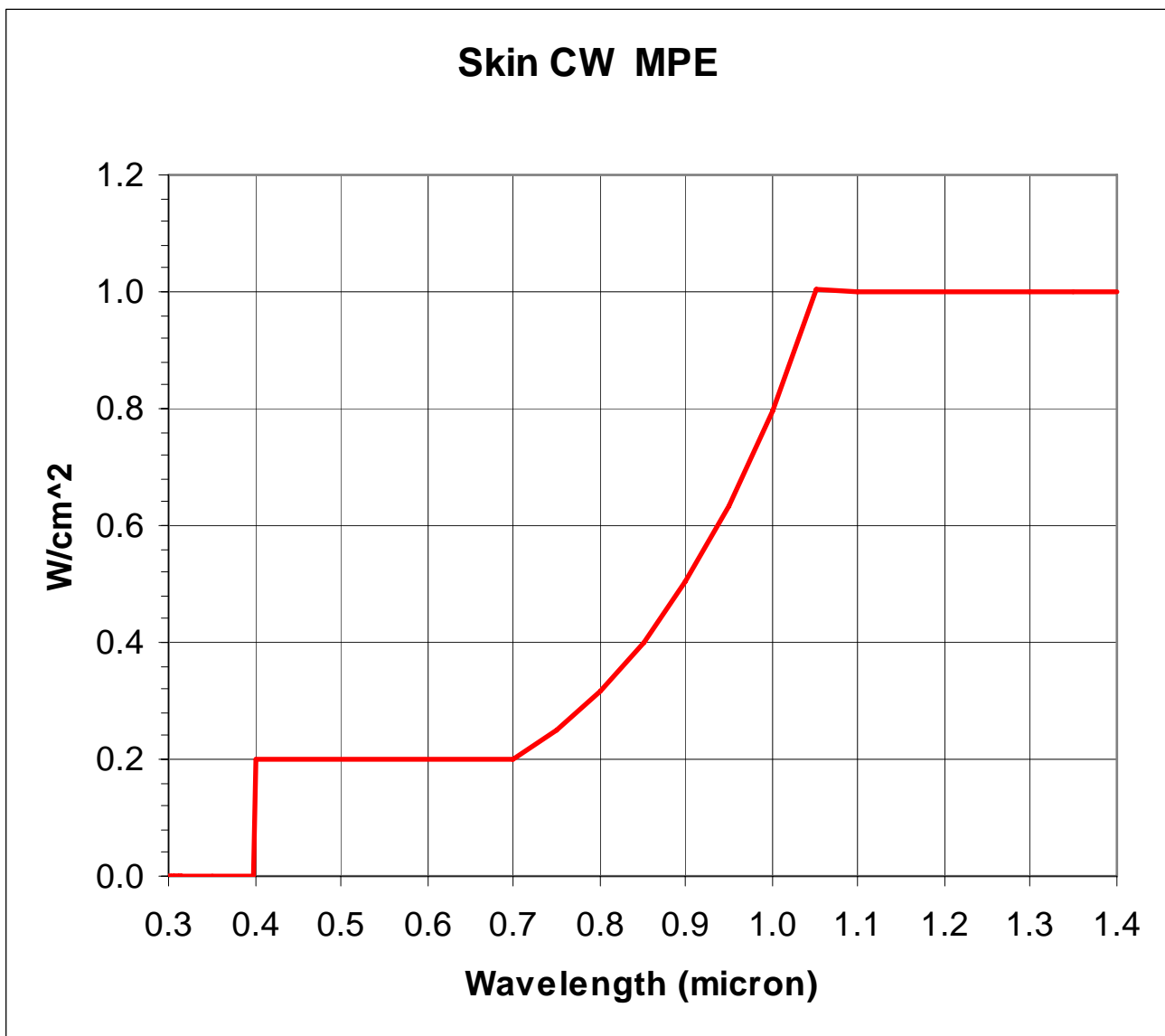

Skin Damage Pulsed Maximum Permissible Exposure

- Pulse MPE much more complex in wavelength and pulse duration
- ANSI Z136.1-2000 has complicated formulas
- Plot below is for a single pulse
- If using multiple pulses then must single pulse must meet this limit
- Total must meet the limit for the combined pulse stream duration
- Eg. Stream of 1 nsec pulse each separated by 1 nsec
- Must meet also maximum for 20 nsec exposure

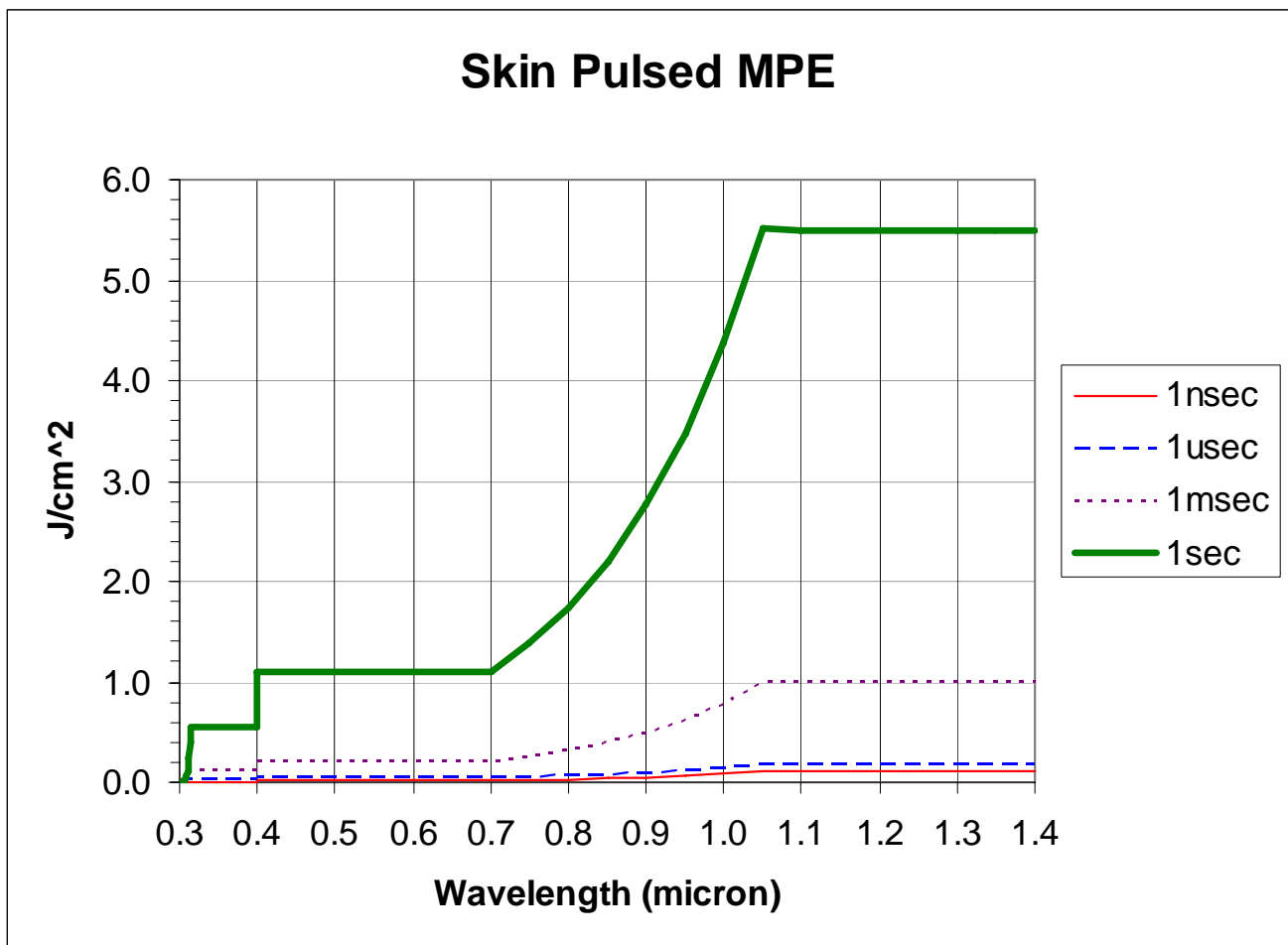

Skin Damage MPE Tables & Spreadsheet

- Spreadsheet calculating Skin MPE gives values
- ANSI Z136.1-2000 has complicated formulas so in the spreadsheet
- Download from notes page or Laser Safety web page
<http://www.ensc.sfu.ca/people/faculty/chapman/e894/lasersafety.html>
- Columns show wavelength, CW and various pulse
- Use last column (green) for different times from estimate
- Just put in selected time

Skin Maximum Permitted Exposures ANSIZ136.1-2000
 Prof. Glenn Chapman, School Eng. Science, Simon Fraser Univ. Copyright 2006

Wavelength micron	CA	CW MPE		Pulsed MPE				
		W/cm ²		J/cm ²				
		CW	1.00E-09	1.00E-06	1.00E-03	1.00E+00	1.00E+00	time(s)
0.3000	1.0000	0.0010	0.0030	0.0030	0.0030	0.0030	0.0030	0.0030
0.3010	1.0000	0.0010	0.0030	0.0030	0.0030	0.0030	0.0030	0.0030
0.3020	1.0000	0.0010	0.0030	0.0030	0.0030	0.0030	0.0030	0.0030
0.3030	1.0000	0.0010	0.0031	0.0040	0.0040	0.0040	0.0040	0.0040
0.3040	1.0000	0.0010	0.0031	0.0060	0.0060	0.0060	0.0060	0.0060
0.3050	1.0000	0.0010	0.0031	0.0100	0.0100	0.0100	0.0100	0.0100
0.3060	1.0000	0.0010	0.0031	0.0160	0.0160	0.0160	0.0160	0.0160
0.3070	1.0000	0.0010	0.0031	0.0177	0.0250	0.0250	0.0250	0.0250
0.3080	1.0000	0.0010	0.0031	0.0177	0.0400	0.0400	0.0400	0.0400
0.3090	1.0000	0.0010	0.0031	0.0177	0.0630	0.0630	0.0630	0.0630
0.3100	1.0000	0.0010	0.0031	0.0177	0.0996	0.1000	0.1000	0.1000
0.3110	1.0000	0.0010	0.0031	0.0177	0.0996	0.1600	0.1600	0.1600
0.3120	1.0000	0.0010	0.0031	0.0177	0.0996	0.2500	0.2500	0.2500
0.3130	1.0000	0.0010	0.0031	0.0177	0.0996	0.4000	0.4000	0.4000
0.3140	1.0000	0.0010	0.0031	0.0177	0.0996	0.5600	0.5600	0.5600
0.3150	1.0000	0.0010	0.0031	0.0177	0.0996	0.5600	0.5600	0.5600
0.3500	1.0000	0.0010	0.0031	0.0177	0.0996	0.5600	0.5600	0.5600
0.3990	1.0000	0.0010	0.0031	0.0177	0.0996	0.5600	0.5600	0.5600
0.4000	1.0000	0.2000	0.0200	0.0348	0.1956	1.1000	1.1000	1.1000
0.4500	1.0000	0.2000	0.0200	0.0348	0.1956	1.1000	1.1000	1.1000
0.5000	1.0000	0.2000	0.0200	0.0348	0.1956	1.1000	1.1000	1.1000
0.5500	1.0000	0.2000	0.0200	0.0348	0.1956	1.1000	1.1000	1.1000
0.6000	1.0000	0.2000	0.0200	0.0348	0.1956	1.1000	1.1000	1.1000
0.6500	1.0000	0.2000	0.0200	0.0348	0.1956	1.1000	1.1000	1.1000
0.7000	1.0000	0.2000	0.0200	0.0348	0.1956	1.1000	1.1000	1.1000
0.7500	1.2589	0.2518	0.0252	0.0438	0.2463	1.3848	1.3848	1.3848
0.8000	1.5849	0.3170	0.0317	0.0551	0.3100	1.7434	1.7434	1.7434
0.8500	1.9953	0.3991	0.0399	0.0694	0.3903	2.1948	2.1948	2.1948
0.9000	2.5119	0.5024	0.0502	0.0874	0.4914	2.7631	2.7631	2.7631
0.9500	3.1623	0.6325	0.0632	0.1100	0.6186	3.4785	3.4785	3.4785
1.0000	3.9811	0.7962	0.0796	0.1385	0.7787	4.3792	4.3792	4.3792
1.0500	5.0119	1.0024	0.1002	0.1743	0.9804	5.5131	5.5131	5.5131
1.1000	5.0000	1.0000	0.1000	0.1739	0.9781	5.5000	5.5000	5.5000
1.1500	5.0000	1.0000	0.1000	0.1739	0.9781	5.5000	5.5000	5.5000
1.2000	5.0000	1.0000	0.1000	0.1739	0.9781	5.5000	5.5000	5.5000
1.2500	5.0000	1.0000	0.1000	0.1739	0.9781	5.5000	5.5000	5.5000
1.3000	5.0000	1.0000	0.1000	0.1739	0.9781	5.5000	5.5000	5.5000
1.3500	5.0000	1.0000	0.1000	0.1739	0.9781	5.5000	5.5000	5.5000
1.4000	5.0000	1.0000	0.1000	0.1739	0.9781	5.5000	5.5000	5.5000

Laser Classes

- Set by American National Standards Institute
ANSI z136.1 (1986)
- Also British Standards Institute BSI 4803 (1983)
- International European Convention IEC 825 (1984)
- Main worries are Eye damage & Electrical shock
- Control measures mean they must be marked & controlled

Class	Control Measures*	Medical Surveillance
1	Not applicable	Not applicable
2	Applicable	Not applicable
3	Applicable	Applicable
4	Applicable	Applicable

*In normal operation only. Alignment and maintenance procedures of an enclosed Class 2, 3, or 4 laser shall require programs appropriate to the unenclosed laser classification.

Table 8.2.		Classification of Lasers
Class	Definition	
1	Intrinsically safe < 0.2 μ J in 1ns pulse or < 0.7mJ in a 1s pulse	
2	Eye protection achieved by blink reflex (0.25s) < 1mW CW laser	
3A	Protection by blink and beam size <5mW with 25W/m ² (e.g. an 16mm beam diameter from a 5mW laser)	
3B	Possible to view diffuse reflection < 2.4mJ for 1ns pulse or < 0.5W CW visible	
4	All lasers of higher power Unsafe to view directly, or by diffuse reflection May cause fire Standard safety precautions must be observed (Section 8.4.)	

Class 2 and Blink Reflex

- Has Maximum Permissible Exposure (MPE) Levels for visible
- Max allowable level without eye protection
- With Class 2 lasers eye blinking helps increase exposure
- eg 1 mW HeNe laser, 3 mm beam: Power density = 14 mW/cm^2
- However in Eye is focused to 1.4 KW/cm^2
- MPE levels for that are 0.25 sec at retina
- About typical blink response time
- Hence brightness causes eye to shut before damage
- However you can force yourself to look and thus create damage
- Laser pointers are class 2 thus must be very careful around kids

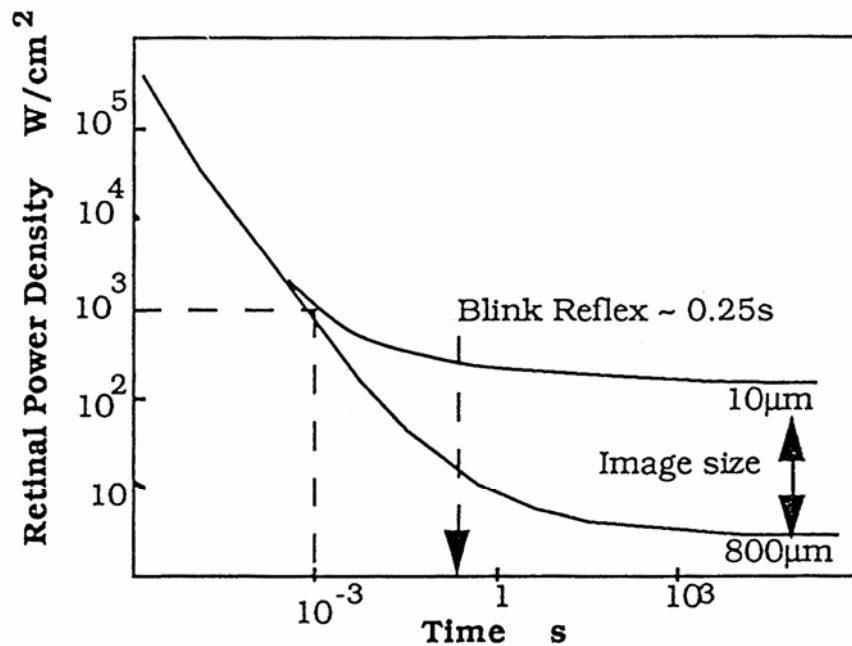

Fig. 8.2. Approximate exposure limits for the retina.

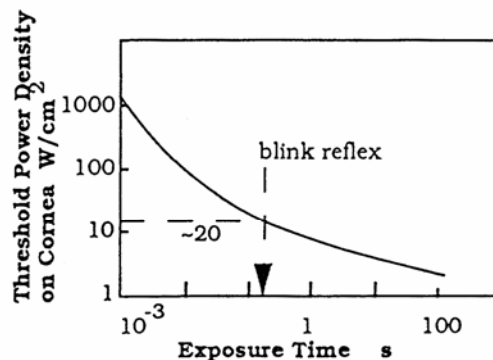

Fig. 8.3. Approximate damage threshold power densities for the cornea of the eye.

Laser Classes: Continuous Wave

- CW mostly changes with wavelength
- In visible class 1 max is ~0.2mW
- Class 2 only exists for CW visible lasers
- Many laser pointers are Class 2

Table 1 Summary of Levels of Power Emissions for Continuous-Wave* Laser and Laser System Classification

Wavelength range (μm)	Emission duration (s)	Class 1†	Class 2‡	Class 3§	Class 4
Ultraviolet 0.2-0.4	3×10^4	$\leq 0.8 \times 10^{-9}$ W to $\leq 8 \times 10^{-6}$ W depending on wave- length (. . .)	–	> Class 1 but ≤ 0.5 W depending on wavelength (. . .)	> 0.5 W
Visible 0.4-0.55	3×10^4	$\leq 0.4 \times 10^{-6}$ W	> Class 1 but $\leq 1 \times 10^{-3}$ W	> Class 2 but ≤ 0.5 W	> 0.5 W
Visible and Near Infrared 0.55-1.06	3×10^4	$\leq 0.4 \times 10^{-6}$ W to $\leq 200 \times 10^{-6}$ W depending on wave- length (. . .)	–	> Class 1 but ≤ 0.5 W depending on wavelength (. . .)	> 0.5 W
Near Infrared 1.06-1.4	3×10^4	$\leq 200 \times 10^{-6}$ W	–	> Class 1 but ≤ 0.5 W	> 0.5 W
Far Infrared 1.4- 10^2	> 10	$\leq 0.8 \times 10^{-3}$ W	–	> Class 1 but ≤ 0.5 W	> 0.5 W
Submillimeter 10^2 - 10^3	> 10	≤ 0.1 W	–	> Class 1 but ≤ 0.5 W	> 0.5 W

*Emission duration ≥ 0.25 s.

†When the design or intended use of the laser or laser system ensures personnel exposures of less than 10^4 s in any 24-hour period, the limiting exposure duration may establish a higher exempt power level, as discussed in 3.2.3.

‡See 3.3.2.3 for explanation of this 2a laser.

§For 1-5 mW cw laser systems (Class 3a) see 4.1.2.3 and 4.6.2.

Laser Classes: Pulsed

- Set by American National Standards Institute
- Note: Class 2 does not exist for pulsed
- For pulsed both pulse duration and total energy are specified

Table 2 Summary of Levels (Energy and Radiant Exposure Emissions) for Single-Pulsed Laser and Laser System Classification*

Wavelength range (μm)	Emission duration (s)	Class 1	Class 3	Class 4
Ultraviolet† 0.2-0.4	$> 10^{-2}$	$\leq 24 \times 10^{-6} \text{ J}$ to $7.9 \times 10^{-3} \text{ J}$	$> \text{Class 1 but } \leq 10 \text{ J} \cdot \text{cm}^{-2}$	$> 10 \text{ J} \cdot \text{cm}^{-2}$
Visible 0.4-0.7	10^{-9}	$\leq 0.2 \times 10^{-6} \text{ J}$	$> \text{Class 1 but } \leq 31 \times 10^{-3} \text{ J} \cdot \text{cm}^{-2}$	$> 31 \times 10^{-3} \text{ J} \cdot \text{cm}^{-2}$
	to 0.25	$\leq 0.25 \times 10^{-3} \text{ J}$	$> \text{Class 1 but } \leq 10 \text{ J} \cdot \text{cm}^{-2}$	$> 10 \text{ J} \cdot \text{cm}^{-2}$
Near infrared‡ 0.7-1.06	10^{-9}	$\leq 0.2 \times 10^{-6} \text{ J}$ to $2 \times 10^{-6} \text{ J}$	$> \text{Class 1 but } \leq 31 \times 10^{-3} \text{ J} \cdot \text{cm}^{-2}$	$> 31 \times 10^{-3} \text{ J} \cdot \text{cm}^{-2}$
	to 0.25	$\leq 0.25 \times 10^{-3} \text{ J}$ to $1.25 \times 10^{-3} \text{ J}$	$> \text{Class 1 but } \leq 10 \text{ J} \cdot \text{cm}^{-2}$	$> 10 \text{ J} \cdot \text{cm}^{-2}$
1.06-1.4 1.06-1.4	10^{-9}	$\leq 2 \times 10^{-6} \text{ J}$	$> \text{Class 1 but } \leq 31 \times 10^{-3} \text{ J} \cdot \text{cm}^{-2}$	$> 31 \times 10^{-3} \text{ J} \cdot \text{cm}^{-2}$
	to 0.25	$\leq 1.25 \times 10^{-3} \text{ J}$	$> \text{Class 1 but } \leq 10 \text{ J} \cdot \text{cm}^{-2}$	$> 10 \text{ J} \cdot \text{cm}^{-2}$
Far infrared 1.4- 10^2	10^{-9}	$\leq 80 \times 10^{-6} \text{ J}$	$> \text{Class 1 but } \leq 10 \text{ J} \cdot \text{cm}^{-2}$	$> 10 \text{ J} \cdot \text{cm}^{-2}$
	to 0.25	$\leq 3.2 \times 10^{-3} \text{ J}$	$> \text{Class 1 but } \leq 10 \text{ J} \cdot \text{cm}^{-2}$	$> 10 \text{ J} \cdot \text{cm}^{-2}$
Submillimeter 10^2 - 10^3	10^{-9}	$\leq 10 \times 10^{-3} \text{ J}$	$> \text{Class 1 but } \leq 10 \text{ J} \cdot \text{cm}^{-2}$	$> 10 \text{ J} \cdot \text{cm}^{-2}$
	to 0.25	$\leq 0.4 \text{ J}$	$> \text{Class 1 but } \leq 10 \text{ J} \cdot \text{cm}^{-2}$	$> 10 \text{ J} \cdot \text{cm}^{-2}$

*There are no Class 2 single-pulsed lasers.

†Wavelength dependent (...).

‡Diffuse reflection criteria (...) apply from 10^{-9} to $33 \times 10^{-3} \text{ s}$ for Class 3. For $> 33 \times 10^{-3} \text{ s}$ exposure, the maximum radiant exposure is $10 \text{ J} \cdot \text{cm}^{-2}$. Class 1 and 3 values are wavelength dependent (...).

Damage Hazards from Typical Lasers

- NIR wavelength Nd:Yag damaging to widest tissue range
- Yet it is not visible
- Excimer XeF next most dangerous due to photoablation effects destroys composition of tissue & penetrates to eye lens

Table 8.1	Basic Laser Biological Hazards					
Laser Type	Wavelength μm	Biological Effects	Skin	Cornea	Lens	Retina
CO ₂	10.6	Thermal	X	X		
H ₂ F ₂	2.7	Thermal	X	X		
Erbium-YAG	1.54	Thermal	X	X		
Nd-YAG	1.33	Thermal	X	X	X	X
Nd-YAG	1.06	Thermal	X			X
GaAs Diode	0.78-0.84	Thermal	**		X	
He/Ne	0.633	Thermal	**		X	
Argon	0.488-0.514	Thermal photochem	X			X
Excimer: XeF	0.351	Photochem	X	X	X	
XeCl	0.308	Photochem	X	X		
KrF	0.254	Photochem	X	X		

** Insufficient power

Older Laser Warning Signs

- Class 2, 3a Yellow/Black
- Class 3b, 4 White, Black & Red
- Note laser light burst symbol

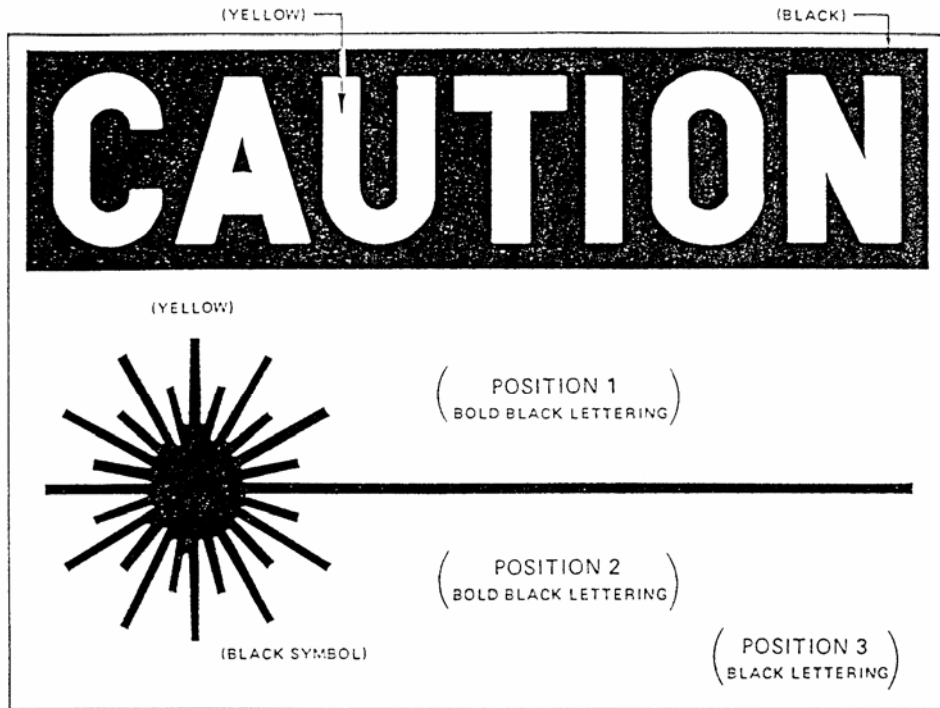

Figure 1 Sample warning sign for Class 2 and 3a lasers.

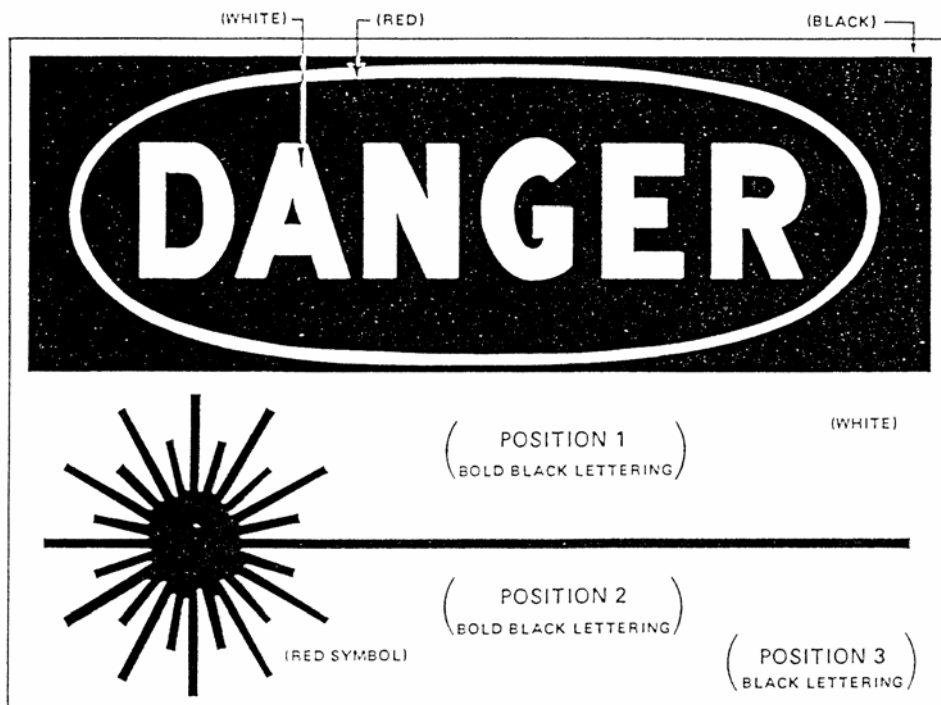



Figure 2 Sample warning sign for Class 3b and 4 lasers.

Newer Laser Warning Signs

- Class 2, 3a Yellow/Black
- Class 3b, 4 White, Black & Red
- Blue for laser repair



! **CAUTION**

 **LASER RADIATION:** Avoid eye or skin exposure to direct or scattered radiation

TWO LASERS: 1083 nm 2 mWatts **CLASS 3a LASER RADIATION**

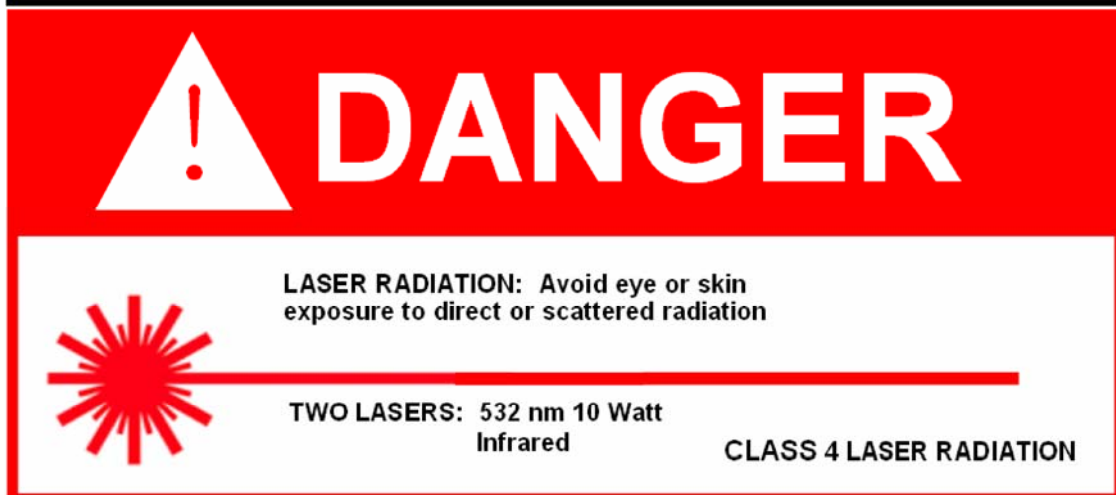

! **DANGER**

 **LASER RADIATION:** Avoid eye or skin exposure to direct or scattered radiation

TWO LASERS: 532 nm 10 Watt Infrared **CLASS 4 LASER RADIATION**



NOTICE

LASER REPAIR IN PROGRESS

DO NOT ENTER
EYE PROTECTION REQUIRED

Class 4 Safety Arrangements

- Must wear Goggles in area
for CO₂ may just be glasses
- Should be flashing Red warning lights
- Standard Laser Danger Signs
- Beam must terminate in dump which can take the power
eg big block of metal that will not overheat
- Stray specular reflections must be contained
- Extreme care when aligning beam
do this at low power and filtered

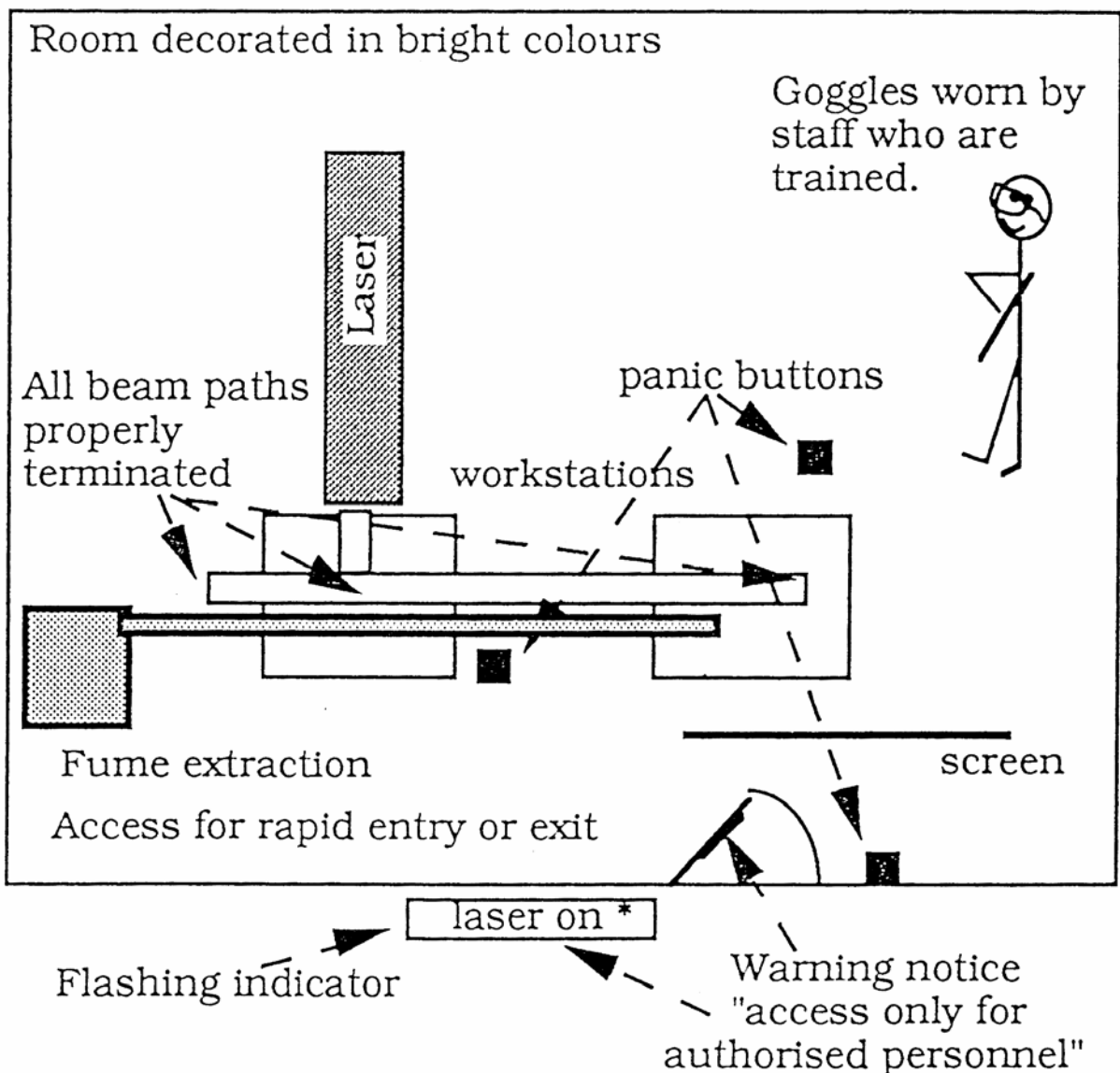

Fig.8. 4. Diagram illustrating safety features of a laser laboratory.

Other Possible Hazards

- Electrical power supplies have high voltages
real danger with water cooling
- High temperatures may decompose materials
- Can create dangerous chemicals
Possibility of fires

Table 8.3.	Main Decomposition Products from Laser Cut Non-Metallic Materials (2)				
Decomposition Products	Material				
	Polyester	Leather	PVC	Kevlar	Kevlar/Epoxy
Acetylene	0.3-0.9	4.0	0.1-0.2	0.5	1.0
Carbon monoxide	1.4-4.8	6.7	0.5-0.6	3.7	5.0
Hydrogen chloride			9.7-10.9		
Hydrogen cyanide				1.0	1.3
Benzene	3.0-7.2	2.2	1.0-1.5	4.8	1.8
Nitric dioxide				0.6	0.5
Phenyl acetylene	0.2-0.4			0.1	
Styrene	0.1-1.1	0.3	0.05	0.3	
Toluene	0.3-0.9	0.1	0.06	0.2	0.2